

# THE SOUTHERN CALIFORNIA INTEGRATED GPS NETWORK (SCIGN)

Kenneth W. Hudnut,<sup>1</sup> Yehuda Bock,<sup>2</sup> John E. Galetzka,<sup>1</sup>  
Frank H. Webb,<sup>3</sup> and William H. Young<sup>4</sup>

## ABSTRACT

This paper describes the fundamental scientific and observational goals of the Southern California Integrated GPS Network (SCIGN). It also reviews the organizational structure, the project management, and important policies. Recent accomplishments are also discussed in some detail, in particular the effective response following the October 16, 1999 Hector Mine earthquake ( $M_w$ 7.1). The scientific motivation for establishing a continuous GPS network to observe time transient crustal deformation is discussed in detail, especially as it pertains to the 1990's sequence of fault interaction and postseismic deformation in the eastern California shear zone. As of March 2001, a total of 239 SCIGN stations are operating; 170 of the newest stations were installed by a contractor. The third phase of network construction was recently completed at an average rate of 2 new stations per week. Network implementation is continuing, and construction of the final 16 stations will be fully completed by July 1, 2001.

---

<sup>1</sup> *United States Geological Survey, Pasadena (SCIGN-USGS Operations Group)*

<sup>2</sup> *University of California, San Diego*

<sup>3</sup> *Jet Propulsion Laboratory, Caltech*

<sup>4</sup> *League of California Surveying Organizations*

## INTRODUCTION

SCIGN is an array of Global Positioning System (GPS) stations distributed throughout Southern California with emphasis on the greater Los Angeles metropolitan region. The major objectives of the array are:

- 1) To provide regional coverage for estimating earthquake potential throughout Southern California
- 2) To identify active blind thrust faults and test models of compressional tectonics in Los Angeles
- 3) To measure local variations in strain rate that might reveal the mechanical properties of earthquake faults
- 4) In the event of an earthquake, to measure permanent crustal deformation not detectable by seismographs, as well as the response of major faults to the regional change in strain

These scientific purposes and the network design were developed through several collaborative workshops, as well as by meetings and extensive committee work. Despite the considerable logistical constraints on siting, the design of the network remained driven by the scientific intent.

Data from all SCIGN stations are freely available on-line, as are coordinate solutions, periodic velocity solutions, and other products. Users of data and products are asked to simply acknowledge SCIGN and its sponsors; the W.M. Keck Foundation, NASA, NSF, USGS, and SCEC. These data and additional detailed information on the project are all available at the SCIGN web site - <http://www.scign.org/>

In addition to these scientific purposes, the data will benefit the Surveying, Engineering and Geographic Information System (GIS) communities who are using SCIGN as the basis for their spatial reference system. The new High Precision Geodetic Network for the state of California, which is the fundamental official geodetic control system, will be based upon data from SCIGN stations (and other continuously operating GPS stations in Central and Northern California).

New SCIGN stations are constructed with a 10-meter deep, five-legged monument that is isolated from the uppermost 3.5 meters of soil so that seasonal non-tectonic motions are minimized. For longevity, these monuments are built using stainless steel pipe. All sites employ standard choke ring antennas and SCIGN adaptors and radomes, to minimize potential antenna system phase center variations through time (and in the event of equipment changes).

In order to telemeter and process the large quantities of data, SCIGN has developed new programs and automation routines that are shared with other users and code developers. Site information is being maintained using a relational database, developed with SCIGN support, that is proving useful for other global GPS datasets as well. Furthermore, we employ redundant data processing to obtain the very highest accuracy and precision possible from the data.

Stations are currently being installed by a contractor at an average rate of two sites per week. In addition to the approximately 50 SCIGN stations that were built in a variety of styles earlier in the network's growth, we now have over 170 new stations built by a contractor to the new specifications that SCIGN developed. Over the upcoming months, we intend to complete the construction of the array, with a total of 250 stations in the network.

## SCIGN ORGANIZATION AND MANAGEMENT

SCIGN is a Standing Committee of the Southern California Earthquake Center (SCEC). It is governed by the SCIGN Bylaws under the direction of the SCIGN Coordinating Board (CB). Day-to-day development and operations of the array are conducted by the SCIGN Executive Committee (EC). The SCIGN organizational structure was established through a democratic process of meetings and open discussion among a group of collaborating scientists and several of our colleagues from the surveying professional community. The current list of SCIGN Officers, Board, Committees and Councils, as well as the SCIGN organization chart and a representation of the SCIGN project division of responsibilities, are all contained in an appendix to this paper. In addition, the SCIGN project has two external committees whose members are also listed in Appendix A. In part, the success of the SCIGN project stems from its having a solid organizational foundation. In addition, adherence to a participatory management style and government through a democratic process have resulted in the amicable resolution of most of the conflicts that have arisen.

Raising funds for the network was accomplished by the collaborating group through a process of writing several major proposals to potential funding sources. Importantly to the success of the project, SCIGN attempted to bring in funding to the research community that had not previously been available, or would otherwise not necessarily have funded projects in the earth sciences. Our proudest examples of this major success are the initial NSF grant and the W. M. Keck Foundation grant. Funds from within the NASA and USGS programs were obtained primarily through internal competitive processes.

Currently, our colleagues in the land surveying, engineering, and GIS communities are advocating that the State and Federal governments sustain the SCIGN project with ongoing funding to maintain the GPS network as a basic infrastructure requirement. This effort is being pursued through a newly formed non-profit organization, the California Spatial Reference Center (CSRC), which in part will act as a service provider between SCIGN and the practicing land surveyors. The CSRC will replace an aging California geodetic control network that once consisted of 16,000 fixed concrete monuments maintained by the National Geodetic Survey (NGS). The NGS no longer has the manpower or funds to maintain the network. The surveying and engineering community, however, must be able to establish and maintain official coordinates as a legal basis for all surveys in the state. California's spatial reference system needs constant attention due to crustal motion and earthquake deformation, and continuously operating reference stations (CORS) of SCIGN, Bay Area Regional Deformation (BARD), Basin & Range GPS Network (BARGEN), Eastern Basin & Range and Yellowstone (EBRY), Pacific Northwest GPS Array (PANGA) and other scientific GPS arrays will provide this monitoring. These scientific projects' funding, however, is normally not sustained or ensured for the very long-lived application of maintaining the spatial reference system for land surveying applications. Hence, the CSRC will pursue funding the long-term operations of networks originally established for scientific research purposes.

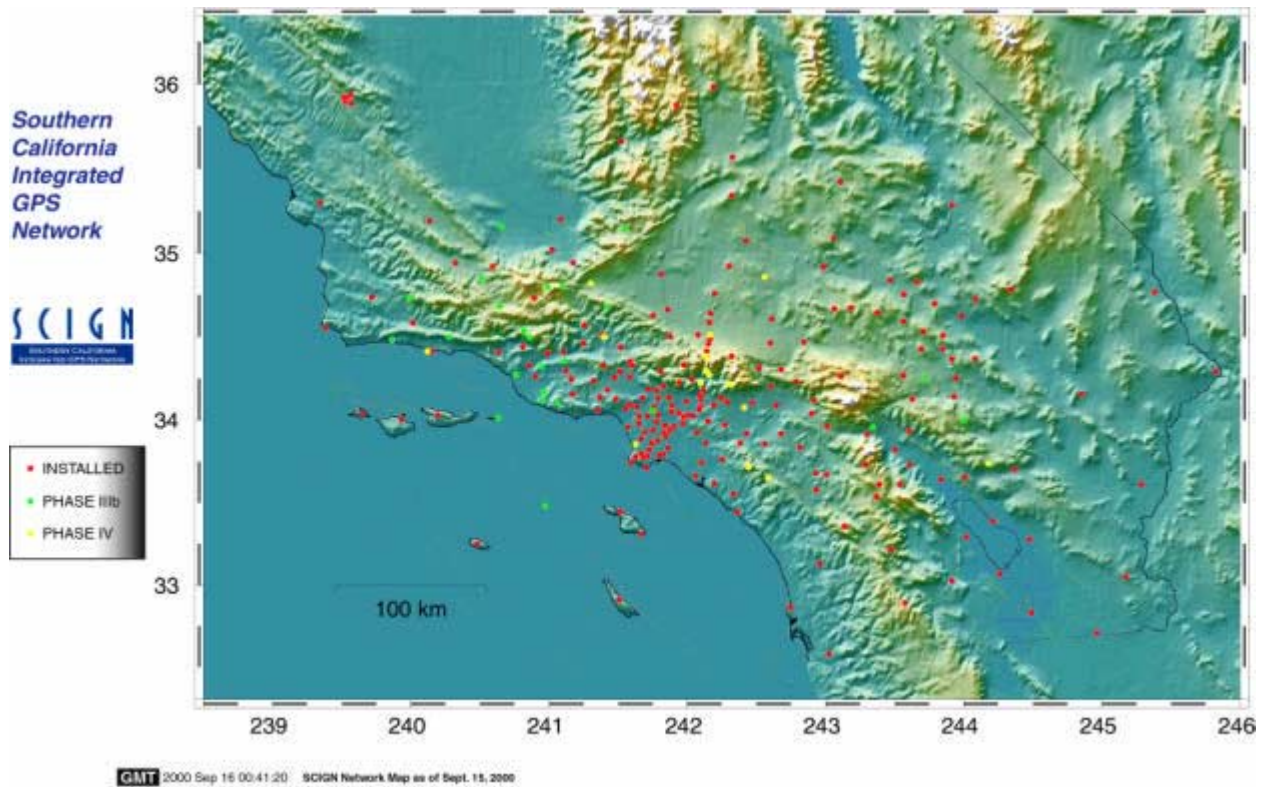

**Figure 1.** Maps showing the SCIGN station distribution and status as of September, 2000. Prior to 1994, a sparse regional network of stations called PGGa was operated. After the 1994 Northridge earthquake, funds from NASA and USGS seeded a more dense network in the Los Angeles area plus regional coverage of the surrounding area. Together, these early efforts established about 50 stations in southern California. Through this effort, the three main groups of station operators joined to form SCIGN and successfully raised funds to install an additional 200 SCIGN sites. As of March 2001, 189 new stations have been constructed for a total now of 239 stations. Sixteen more stations will be installed within the next few months to complete the network installation work.

**Figure 2.** The proliferation of continuous GPS arrays in Western North America will form the nucleus of a Plate Boundary Observatory. The observatory will also include three-component tensor strainmeters, laser strainmeters, broadband seismometers, and SAR imagery. SCIGN participants are playing a very active role in developing the PBO organization and deployment planning, especially with regards to continuous GPS networks in Western North America. The SCIGN project and other similar work by others have proven the scientific value and operational feasibility of such a large-scale deployment.

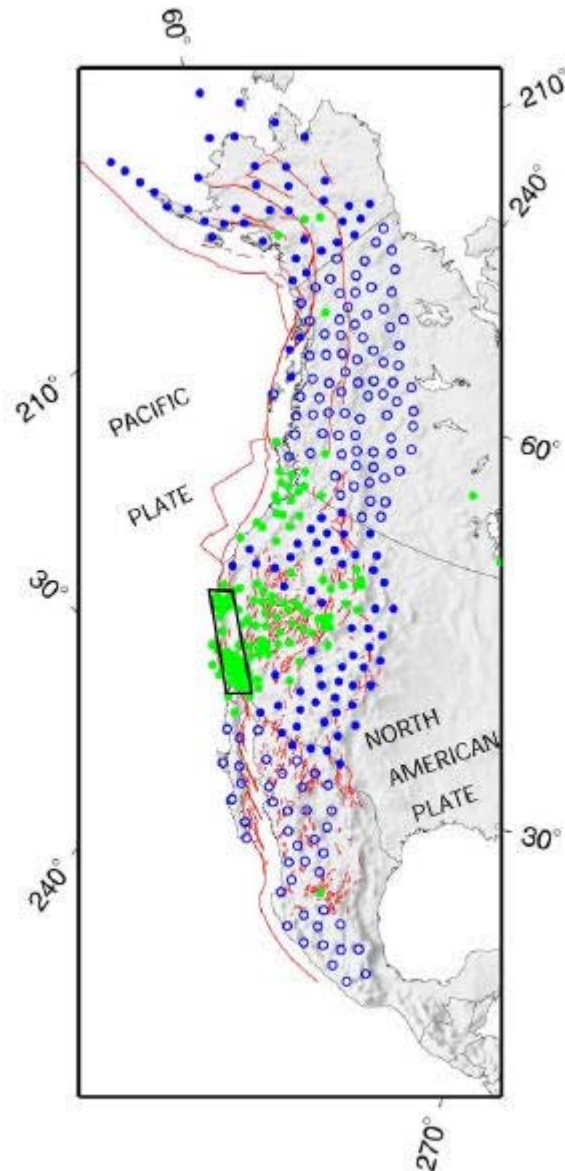

### SCIGN RECENT ACCOMPLISHMENTS

Major recent accomplishments of SCIGN:

- Completed 'Phase II' installation work (the 100th site installed by the contractor was San Gabriel dam site), bringing the number of installed SCIGN sites to a total of 150.
- Finalized selection of sites for the full SCIGN array - a list of 200 sites put forward by the Siting Committee to the Coordinating Board was approved by vote on May 21, 1999. Began work on 'Phase IIIa' of the contract to obtain Site Evaluation Reports for the remaining sites to be installed by the contractor.
- Co-seismic static displacements of up to 190 mm and post-seismic motions of over 10 mm have been recorded by SCIGN for the Hector Mine earthquake ( $M_w$ 7.1). Since the earthquake we re-deployed SCIGN resources to establish 11 new sites. We also converted two survey-mode GPS stations into telemetered continuously operating stations, for a total of 13 new sites. These are being installed to help record the post-seismic deformation field of the earthquake.
- Delivered first reports by the SCIGN Analysis Committee and jointly derived the first SCIGN product, a combined set of co-seismic displacement vectors for the Hector Mine event (for 45 SCIGN stations in common between the three processing groups).



- Finished SCIGN radome development, and brought the SCIGN-developed ASHCAN/EGADS data acquisition software system on-line for all SCIGN stations. Brought the Site Information Manager (SIM) into operational status and continued development of the SCIGN archive's relational database system.
- Participated in formation of the California Spatial Reference Center, a new organization that will provide an interface between SCIGN and the Land Surveying profession.
- Submitted a major proposal to NSF's MRI program, requesting support for continuing technological developments of GPS instrumentation that will help to optimize future deployment of the Plate Boundary Observatory.
- Donated extra pairs of SCIGN receivers and antennas to PANGA, CICESE, and EBY to promote regionally integrated continuous GPS networks, and to foster a federation of cooperating arrays in Western North America.
- Contributed matching support toward the GPS element of a successful National Science Foundation (NSF) Major Research Infrastructure (MRI) proposal that will, in part, establish continuous GPS sites along the San Andreas fault in central California to further link SCIGN and BARD efforts.
- Performed network-wide upgrades to replace all GPS equipment that is not the SCIGN standard hardware, and to prepare for the GPS End-of-Week and Year 2000 (Y2K) by upgrading to a compliant firmware version.
- Continued inventory, distribution, and shipping of the SCIGN GPS equipment so as to carry out the various agreements SCIGN has negotiated with the GPS equipment manufacturer and to obtain upgraded and retrofitted equipment (we are continuing to cycle all SCIGN receivers and antennas back through the manufacturer until all units have been serviced). In related work, SCIGN also performed tests in order to evaluate and accept a new production model of DMCR antenna.
- Completed Phase IIIa (Site Evaluation Reports for Phase IIIb sites).
- Completed Phase IIIb installation contract (64 sites).
- Completed the installation of additional Hector Mine earthquake special post-seismic monitoring sites by SCIGN crews.
- Carried out installations of the Channel Islands, Isla Coronados, and Isla Guadalupe sites by SCIGN crews.
- Continued making progress on upgrading older SCIGN stations.
- Continued making progress on Analysis Committee efforts (see link below to their September, 2000 report). Beginning regular production of combined SCIGN solutions for station positions and velocities.

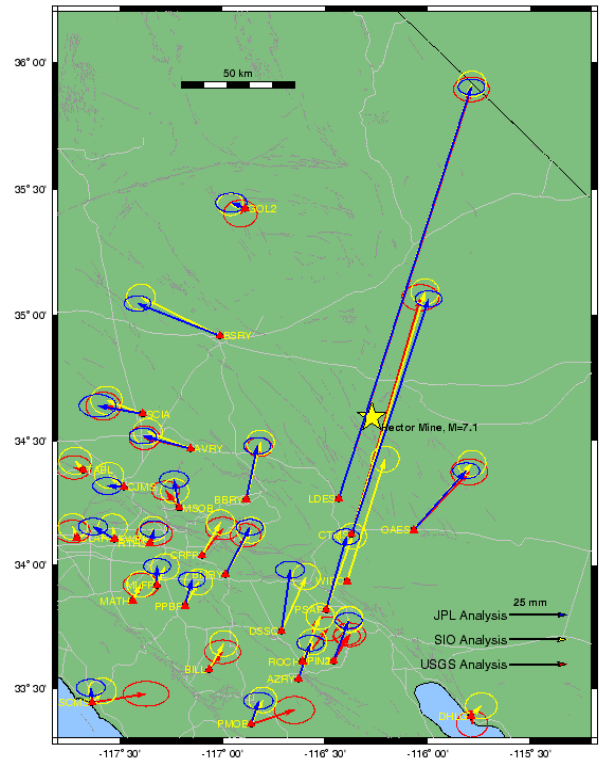

**Figure 3.** Coseismic displacement measurements from SCIGN for the Oct. 16, 1999 Hector Mine earthquake were generated by all three groups and then compared. A combination solution was then formed, which was then put forward as our first official SCIGN analysis product.

<http://pasadena.wr.usgs.gov/nking/Sep2000Report/AnCommReport.html>

- Switching over to sub-daily downloading and processing and continue with other SCIGN developments towards rapid and highly accurate data analysis for improving earthquake response efforts. Completing telemetry network development to bring in data from all Phase II and Hector Mine earthquake sites, and to facilitate telemetry for the Phase IIIb sites as well.

#### TECHNOLOGICAL DEVELOPMENT

GPS instrumentation and infrastructure are playing an increasingly important role in the Earth sciences. Large arrays of continuous GPS stations are being installed to monitor plate boundary deformation and associated seismic hazards, with the largest concentrations in Japan (~1000 stations) and western North America. There are currently about 300 continuous GPS sites in western North America, including Alaska, the continental U.S., Canada, and Mexico (Figure 2). Within the next year, an additional 150 continuous stations will be installed by SCIGN and neighboring networks along the Pacific-North American plate boundary.

These arrays give us an unprecedented capability to image tectonic strain accumulation and release through many earthquakes on a continental scale, opening the possibility of discovering previously unrecognized large-scale deformation processes in the Earth. To increase the resolving power of this new instrumentation, we must continually strive to reduce noise in the observations, and model the noise which cannot be reduced or eliminated. SCIGN's efforts in this regard have been unparalleled, in part because of the stringent scientific requirements we adopted during early days of the project.

SCIGN has been, throughout its ten-year history, at the cutting edge of continuous GPS network technology. Scientists who founded SCIGN have been active in the GPS and earthquake research communities during the past decade in sharing knowledge about setting up networks of very high quality. Along with the Geographical Survey Institute (GSI) network in Japan and several others in the United States (e.g., BARD, BARGEN, EBRY & PANGA), researchers worldwide are pushing ever harder to establish large dense networks of GPS instrumentation. SCIGN has been simultaneously solving problems and refining all aspects of such large-scale operations, including field skills, engineering, telemetry, automated data processing, and web-based visualization. (e.g., Hudnut & Behr, 1998, Behr et al., 1998, Celebi et al., 1999).

In North America, the NSF and other government agencies have funded scientific workshops to develop the main components of EarthScope. Among the main components of EarthScope is the Plate Boundary Observatory (PBO). A major element will be an array of continuously operating GPS stations throughout western North America (Silver et al., 1999). Thus, the use of continuous GPS is on the rise, and SCIGN has pushed forward many development efforts so as to optimize the method. Examples of successful SCIGN development efforts:

- SCIGN radomes (<http://www-socal.wr.usgs.gov/scign/group/dome/>)
- SCIGN adaptors (<http://www-socal.wr.usgs.gov/scign/group/dome/adaptor.html>)
- Monumentation methods:
  - Drilled-braced monuments ([http://jacinto.ucsd.edu/pfo/monument\\_design/intro.html](http://jacinto.ucsd.edu/pfo/monument_design/intro.html))
  - Short braced rod (light equipment & material) monuments
  - Rock pin monuments ([http://www-socal.wr.usgs.gov/scign/hudnut/rock\\_pin.html](http://www-socal.wr.usgs.gov/scign/hudnut/rock_pin.html))
- Autonomous telemetry hub system
- ASHCAN/EGADS system (<http://www-socal.wr.usgs.gov/scign/EGADS/>)
- Automated GPS data processing systems
- Web-based JAVA and cgi-bin systems for display of results
- <http://www-socal.wr.usgs.gov/scign/Analysis/javaplot/index.html>
- <http://lox.ucsd.edu/cgi-bin/Hector.cgi>
- Seamless archive (under the UNAVCO umbrella)
- Relational Database Management System
- Site Information Manager (SIM) (<http://lox.ucsd.edu/whatsNew/sim.html>)
- Site Velocity Generator (<http://lox.ucsd.edu/cgi-bin/Vortex.cgi>)
- Site Coordinates Generator (<http://lox.ucsd.edu/cgi-bin/Pythagoras.cgi>)

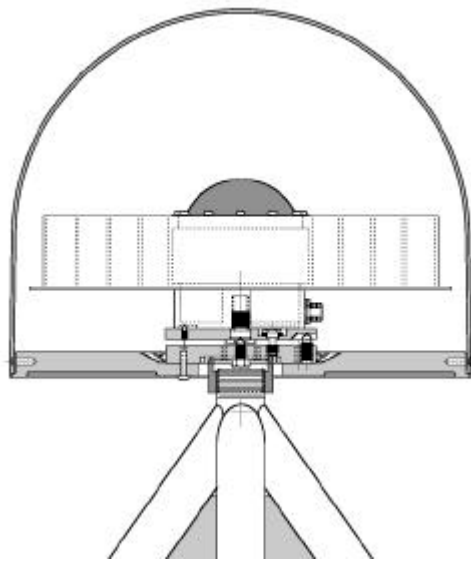

**Figure 4.** The SCIGN monument, adaptor and radome are designed especially for use with Dorne-Margolin Choke Ring antennas. These antennas have become the worldwide standard for precise GPS geodetic research purposes (in the IGS and many regional networks). As this drawing of the assembly shows, the components are designed to provide all necessary functions. The antenna can be readily adjusted to level, oriented to north, and then secured against tampering. Once enclosed, the antenna is protected from the elements, yet the GPS signal distortion due to the radome is expected to cause less than 0.1 mm changes in apparent phase center position.

Through our development efforts, we expect to further refine and enhance the capabilities of continuously operating GPS networks in time to influence the PBO instrumentation. With our completely open data policy, web-accessible shared technical reports and information, and open-source distribution of software developed by SCIGN, our products are available to all of our colleagues so that not only their science but also their GPS network operations can take advantage of SCIGN developments. Furthermore, our pioneering efforts in establishing close ties to the Land Surveying community through the development of the California Spatial Reference Center (CSRC) provide a real-world example of effective professional community outreach.

#### NETWORK INSTALLATION

Prior to the formal existence of the SCIGN project, all three of the main operational groups of SCIGN (SIO, JPL and USGS) had each installed numerous continuously operating GPS stations in the region. Once combined into the formative SCIGN network, these early stations totaled 50. These early stations did not have standardized monumentation and equipment, so the SCIGN plan includes upgrading these stations as necessary and affordable during the project lifetime. At this time, equipment such as receivers and antennas has, for the most part, been standardized throughout these older sites. As SCIGN was funded to expand to a total of 250 sites, we developed a coherent plan for installing as many as possible of the new 200 sites according to specifications that we developed specifically for the SCIGN project.

The SCIGN operations plan outlines the deployment of the 200 new stations into the network in three phases. Phase I was completed in May 1998 and consisted of pre-construction work, the building of three monuments as part of the transfer of knowledge from SCIGN to the contractor, Earth Consultants International (ECI), and the ramping up of the installation effort. Under this phase, the first three stations of the network were built, health and safety plans for the site construction were prepared, and some sites were pre-screened for geologic suitability.





**Figure 5.** Drilling for the installation of the monument legs at station BILL, located at the Metropolitan Water District's facilities at Lake Skinner. This station is named for Bill Young, who is a volunteer contributor to the SCIGN project and member of the EC. The principal of these monuments is to anchor deeply into a large volume of ground at a depth of 12' to 30' while decoupling from the soil that is most likely to creep. It is thought that a major contribution to random long-period (>6 mo.) noise in GPS time series is attributable to monument instability from soil creep.

Phase II of the implementation contract, for the construction of 100 new stations, began in April, 1998 and was completed in September 1999. Concurrent with this stage of the installation work, an additional 100 sites were selected for the network by the SCIGN Siting Committee and Network Coordinator for a total of 200 new SCIGN sites. Most of the new sites have been installed at schools and colleges that welcome SCIGN as an educational opportunity for their students.

SCIGN maintains a close working relationship with ECI to ensure that high quality stations are installed at a reasonable cost to the project. Construction of the sites is monitored through a combination of monthly meetings between SCIGN and ECI, site visits during construction, site inspections following construction, and regular telephone communications among the SCIGN and ECI personnel involved.

If all of the parallel installation efforts listed above (in "Plans for 2000") are carried out according to our current plans, it is plausible that we will be edging the total number of SCIGN sites to approximately 250 by the end of September 2000, in accordance with governmental performance deadlines for network installation.

#### OBSERVING TIME-TRANSIENT DEFORMATION SIGNALS

Post-earthquake deployments for large crustal events, such as SCIGN has done for the Hector Mine event, are crucial if we are to obtain such highly sought-after and valued observations documenting the ephemeral strain pulses generated by large earthquakes. These may act as a kick to the tectonic system, relieving stresses and thereby triggering activity even at great distances. The rates and wavelengths with which postseismic strain transient signals propagate have not been determined or even established with certainty. Improved observations hold the key to understanding the physical nature of postseismic phenomena.



**Figure 6.** SCIGN station equipment enclosure

A series of papers by Mogi, beginning in the late 1960's (Mogi, 1968 a & b, 1974, & 1979), stimulated speculation that large earthquakes can be correlated across large distances and long times. With the implications of Elsasser-type models (an elastic crust over a Maxwell solid half-space) to support them, ideas were advanced beginning in the 1970's on propagating strain pulses (Savage, 1971; Bott & Dean, 1973; Anderson, 1974; Pollitz, 1997). Furthermore, with emphasis on southern California earthquakes, stress change modeling was then used extensively by many investigators during the 1980's and 1990's to explain fault interaction (e.g., King et al., 1994 and references therein). However, such inferential studies have persistently suffered from a lack of direct observational verification. That is, most have presumed that some aspect of earthquake occurrence (e.g., a main shock or the seismicity rate) is triggered by stress, and implicitly strain, changes. It is difficult to prove or

disprove that any earthquake pattern is real, much less that it may be causally connected by a propagating strain pulse

or by stress changes. An attempt at recognizing patterns in western United States regional seismicity, and its relationship to activity on the San Andreas fault zone, is certainly interesting - but it lacks the direct observations of associated transient strains (Press and Allen, 1995). Even for the Turkish 1900's sequence along the North Anatolian fault - the most impressive natural example of a protracted, long distance triggering sequence - it is not entirely clear how the events are connected, if at all. Although stress change modeling can be demonstrated to explain some aspects of the sequence's progression (Stein et al., 1997), alternative viscoelastic models could also certainly be made to fit the observations. With the

newly developing capabilities in continuous GPS arrays, as well as other areas of geodesy (e.g., SAR interferometry), we are in a position to be among the first to observe strain signals associated with such large temporal and spatial scale geophysical events, if they exist. Clearly if they do exist and are observable, this capability would revolutionize both our observational and theoretical basis for all intermediate-term earthquake forecasting. Such a development would clearly represent a breakthrough in earthquake science.

Although the occurrence of two large earthquakes in the eastern California shear zone just eight years apart may be a coincidence, it may also signify a pattern of increased seismicity that is too important to ignore and a possible shift of the locus of plate boundary deformation away from the San Andreas (e.g., Nur et al., 1993) to a zone connecting between the seismically active Imperial and Owens Valleys (Savage et al., 1990). The rate of motion across the Eastern California Shear Zone is now recognized to be as high as 8-12 mm/yr (Sauber et al., 1994). It is unclear whether or not this rate can have been sustained for more than 300,000 years, for example as seen by cumulative bedrock offsets on these faults. Perhaps the rate has recently increased on the ECSZ as it becomes increasingly difficult to push material through the Big Bend of the San Andreas. Alternatively, the geological rate equals the modern long-term rate, but a very long-period strain transient is presently causing a sustained high rate of deformation across the ECSZ that will not continue. This type of behavior might be characteristic of faulting throughout the Basin and Range (Wallace, 1984), since it appears to occur in clusters of activity that are separated by very long time intervals of relative inactivity. It is conceivable that with our new concentration of stations in the vicinity of the greater



**Figure 7.** SCIGN station NOPK - 'as built'

Landers sequence, we may make observations that would help discriminate between these two models (and others that may be equally possible).

For the intensely scrutinized Landers sequence, excellent and extensive geodetic and other data sets were collected, prior to the Hector Mine sequence (e.g., Sieh et al., 1993; Bock et al., 1997; Peltzer et al., 1994, 1996, 1998). With the data we have collected spanning this entire remarkable earthquake sequence, we may very well be able to gain new insights into the true nature of fault interaction over distances of tens of kilometers and decadal time scales. Initial indications reported at the 1999 Fall AGU meeting by numerous investigators indicate that elastic half-space static stress change models do not readily explain the fault interaction between Landers and Hector Mine. Since an easy answer remains elusive, a much more interesting answer is likely in store for us - if we can model and understand the postseismic poroelastic and viscoelastic phenomena. Certainly more work is needed, and will rely on continuing observational efforts, such as the ones proposed herein.

The Hector Mine earthquake will be well investigated with seismological, interferometric SAR, and surface geological studies, making it a natural prototype experiment for the PBO. All SCIGN data and technical innovations will be freely shared with the scientific community. We hope and expect that a wide range of researchers will make these new data central to their research on crustal deformation, the earthquake cycle, and seismic hazards.

### HECTOR MINE EARTHQUAKE RESPONSE

At the time of the Hector Mine earthquake ( $M_w 7.1$ ), on October 16, 1999, SCIGN had, fortunately, recently brought on-line several stations in the vicinity of the earthquake. The data from these new sites have shown both co-seismic steps and post-seismic deformation in the months since the event. Initial results have been published already (USGS/SCEC/CDMG, 2000), and reported upon by numerous investigators at the Hector Mine earthquake special session of the Fall 1999 AGU meeting. At the upcoming SSA 2000 meeting many new results will also be presented based on SCIGN data.

In addition, several SCIGN sites in this area had been built but not yet had their telemetry hookups completed; SCIGN personnel and installation contractors worked to establish telemetry where possible, and begin manual downloading where it was not.

SCIGN also began installing new stations near the earthquake, on the 29 Palms Marine base as Base schedules allowed, and also at nearby sites off the base. Within a few days we established three new sites (e.g., OP Round [Figure 8]) using solar power and radio telemetry.

**Figure 8.** Photo shows SCIGN station OP Round, installed within the week after the Hector Mine earthquake. The pier monument type was later abandoned and we began using a new drilled-braced monument style. Other aspects of the installation work were also refined after these first few stations were emplaced.





These first three were constructed with metal piers that we had earlier fabricated for such rapid deployments. However, we felt that it would be in keeping with our commitment to high standards to use a more stable monument, while keeping in mind the limits imposed on the weight and size of tools and equipment by the need for helicopter transport within a reasonable budget.

During late October and early November, SCIGN worked as a team to develop these new methods, which were then tested in the field at two sites that were both accessible by vehicle. Our experiences with these sites prepared us for the next three helicopter-supported installations in mid-November. Then, in mid-December we installed 2 vehicle-accessible sites on the USMC base (e.g., BEARMAT Hill [Figure 9]), and in one additional 'helicopter day' in December we completed the one site we'd started in November, did trouble-shooting at several sites, and also installed (from scratch) an additional site. We also set up our PC and radios for the GPS data acquisition hub: by January the data from all these new sites was flowing into the SCIGN data stream.

These SCIGN efforts were coordinated with survey-mode GPS measurements made by the Southern California Earthquake Center and the USGS; SCIGN supported and worked side-by-side with SCEC and other collaborating investigators. For two stations (Troy and Siberia) that are part of Meghan Miller's NASA-funded Mojave GPS network study, it was agreed that SCIGN GPS units should be emplaced after other temporarily deployed equipment had to be returned for use on other projects.

As noted above, our aim in developing monumentation for this kind of rapid deployment was to get the best-quality monuments possible, subject to the logistical constraints of helicopter installation, and given the availability of rock outcrops at our planned sites. (The plusses and minuses of mountain-top sites in a desert). We are facing similar constraints for some sites that are part of the main SCIGN plan (the Channel Islands, Isla Coronado, and Isla Guadalupe), and so had already given these questions some thought. Our preference is to deeply anchor the monument whenever possible, using either a drill rig to go the full depth or a jackhammer to go more shallowly; the latter has been used previously at SCIGN stations Holcomb Ridge, San Clemente Island, and Wide Canyon. However, even a jackhammer (with compressor) cannot be carried in any reasonably-available helicopter. We had experimented with various alternatives (coring drills and Cobra drills) and eventually found that generator-powered rotary hammers can work quite well: somewhat miraculously, the 14 Amp Bosch rotary hammer drill that we selected has worked out very well for drilling in a variety of rock types--though not in rock that is poorly consolidated or badly fractured, or in large boulders in a loose matrix.



**Figure 9.** Photo shows a new-style SCIGN station, installed 2 months after the earthquake using the new method of monumentation. Each leg is drilled to one meter depth, and epoxied in place. The legs are then welded together at a junction just below the SCIGN adaptor, antenna and radome.

The final monument design is shown in Figure 9: a braced tripod, which each leg epoxied into a hole about 1 meter deep. Installation of this is fairly simple: drill the vertical hole, determine the piercing points

for the other legs, drill the holes for them, cement in all the legs, weld them together, and weld an adaptor-mount onto the vertical one at the intersection point. SCIGN is calling this type of monument a 'SCIGN short braced rod monument' and will be making a description of it widely available to the GPS community, as we have for our other designs.

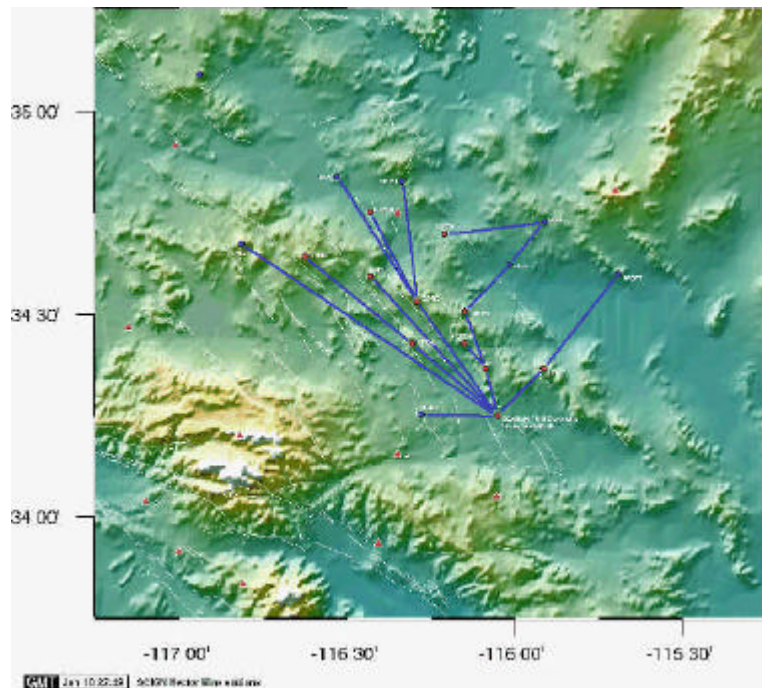

**Figure 10.** The telemetry system installed after the Hector Mine earthquake was established using spread spectrum radios. The data are transmitted back to a stand-alone computer at an unmanned building on BEARMAT Hill. This computer runs automated ASHCAN/EGADS software to download and manage data from this sub-array of SCIGN stations. This system allows the GPS data to be retrieved at higher sampling rates and in near real-time much more readily than our standard telephone line dial-up telemetry system.

Of the 11 sites installed in response to the Hector Mines event, 8 used this drilled-braced tripod monument. Six of these 11 sites required helicopter access (the other 5 being 4WD). We expect to install 5 more such sites (with helicopter support) on the Channel Islands beginning in April, which will allow us to refine the design and procedures even more.

The average cost of the standard SCIGN site to date has been about \$20,000 (not including GPS hardware, site selection, site permitting or site evaluation reports). The costs of these post-Hector installations was less than half of that, partly reflecting the lower cost for monumentation, but also differences between working in a desert as against an urban environment.

Of course, in lowering the cost and the logistical requirements, this design of monument also sacrifices the very high stability we have aimed to get in our installations in the rest of SCIGN; and of course, since it requires competent bedrock, it could not have been applied to most of the area being studied by SCIGN. Given the need for promptness in making post-earthquake measurements, the logistical constraints in the epicentral region, and the much higher rates associated with post-seismic signals, we feel that we have made a reasonable trade-off in deploying this design.

Needless to say, we feel that this style of site installation will have broad application within the Plate Boundary Observatory and elsewhere globally. This method, we have found, is also less intimidating to potential site hosts. They seem more willing to give us permits to perform such installations than to bring in our full-sized drill rigs. Although this method certainly does require competent bedrock, we feel that will be available for many or all of the PBO 'backbone' sites and many of the sites in the dense subnetworks of the PBO. One can readily see that the environmental impact of such installations is much less than for the regular drilled SCIGN sites.



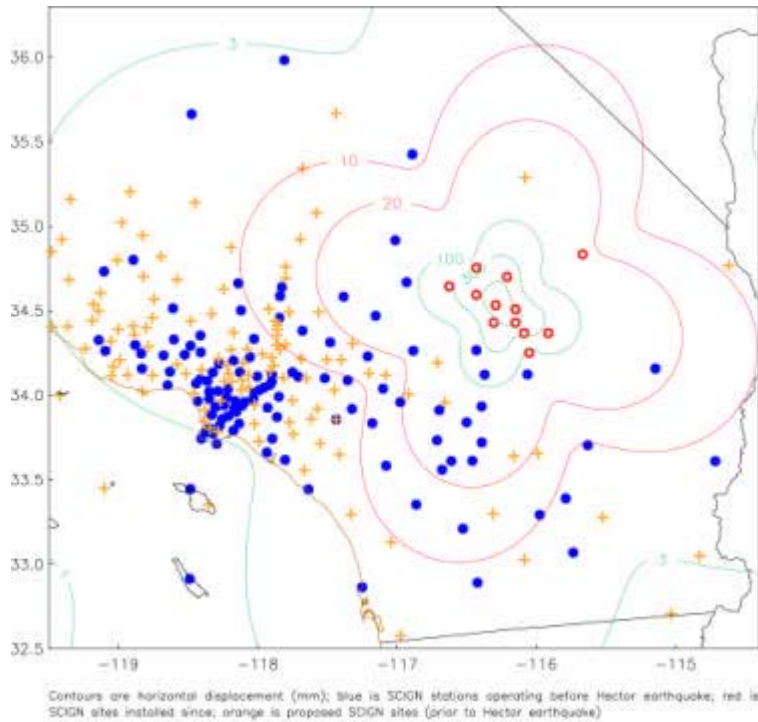

**Figure 11.** Map showing contours of modeled horizontal displacement associated with the Hector Mine earthquake. The entire southern California region sustained static displacements large enough to be measured at SCIGN stations (the 3 mm contour represents an easily detected signal). Right-lateral surface rupture was as large as 5.25 meters, so in areas close to the fault, survey-mode GPS sites may have been displaced by large amounts. The largest motion at a SCIGN site was 190 mm. We have recorded postseismic transient deformation as well as the coseismic deformation signal.

## CONCLUSIONS

The SCIGN project began with ambitious observational and scientific goals, many of which are starting to be addressed by data already collected by the array. The project scientists remain determined to run the course of the project in order to optimally record the data necessary to address the original scientific questions posed in the early proposals (and stated in the introduction of this paper). Development of new hardware and software by SCIGN, in order to optimize high precision GPS, has always been treated as an integral and vital part of the network deployment. The interseismic station velocities, as well as coseismic positional jumps and postseismic transient deformations recorded by SCIGN provide a unique type of information that enables a wide range of quantitative geophysical modeling. Most recently, the essential observational role of SCIGN has been demonstrated for the Hector Mine earthquake. The network installation is nearing completion, and once it is fully operational the design goal is that it will then be run continuously for five years. At this time, we have not yet identified all of the resources needed to make this possible – more fundraising will be needed for operation and maintenance of SCIGN to fulfill its projected observational role. As the world's second major GPS network, following Japan's nationwide array, SCIGN demonstrates the utility of continuous GPS in a networked mode of operation. In the same manner that networks of seismic instruments have changed seismology, we hope that these large GPS networks will also create new opportunities and positive changes in geodetic research. Perhaps most of all, we hope to be able to observe things that we could never have observed before this technology existed.

## ACKNOWLEDGMENTS

We thank the many participants in SCIGN for contributing material used in this paper, especially Nancy King (Fig. 1), Matt van Domselaar (Fig. 3), Frank Wyatt (Fig. 4), and Duncan Agnew (Fig. 11). Nancy King and Sue Hough kindly reviewed an earlier version of this manuscript. Funding for SCIGN has been provided by the W. M. Keck Foundation, NSF, NASA, SCEC, USGS, and Riverside County Flood and Water Conservation District.

## APPENDIX:

### CURRENT SCIGN OFFICERS, BOARDS, COMMITTEES AND COUNCILS

#### ***Executive Committee***

Ken Hudnut, Coordinating Board Chair (U. S. Geological Survey)  
Yehuda Bock, Coordinating Board Vice Chair (Scripps Institution of Oceanography)  
Bill Young (League of California Surveying Organizations)  
Frank Webb (NASA/Jet Propulsion Laboratory)

#### ***Coordinating Board***

Duncan Agnew (Scripps Institution of Oceanography, U.C. San Diego)  
Yehuda Bock (Scripps Institution of Oceanography, U.C. San Diego)  
Dick Davis (California Department of Transportation)  
Andrea Donnellan (NASA/Jet Propulsion Laboratory)  
Don D'Onofrio (NOAA/NOS/National Geodetic Survey)  
David Jackson (University of California, Los Angeles)  
Ken Hudnut (U.S. Geological Survey)  
Nancy King (U.S. Geological Survey)  
Susan Owens (Univ. of Southern California)  
Will Prescott (U.S. Geological Survey)  
Mike Watkins (NASA/Jet Propulsion Laboratory)  
Frank Webb (NASA/Jet Propulsion Laboratory)  
Steve Wesnousky (Univ. of Nevada, Reno)  
Frank Wyatt (Scripps Institution of Oceanography, U.C. San Diego)  
Bill Young (League of California Surveying Organizations)

#### ***Ex Officio members of Coordinating Board***

Tom Henyey, SCEC Center Director, (University of Southern California)  
J. Bernard Minster, SCEC Science Director, (University of California San Diego)

#### ***Other SCIGN Officers***

John McRaney, Network Administrator, (University of Southern California)  
John Galetzka, Network Coordinator, (USC/U. S. Geological Survey)  
Myra Medina, Network Secretary, (Scripps Institution of Oceanography)

#### ***Analysis Committee (acting membership - pending approval by SCIGN CB)***

Nancy King, chair (USGS)  
Ken Hurst (JPL)  
Matt van Domselaar (SIO)  
John Langbein (USGS)

**Other SCIGN Staff**

Aris Aspiotes (USGS), Electronic/Field Technician  
 Jeff Behr (USC/USGS), Programmer  
 Mike Heflin (JPL), Programmer/Analyst  
 Paul Jamason (SIO), Field Technician  
 Mark Smith (JPL), Field Technician  
 Keith Stark (USC/USGS), Programmer  
 David Stowers (JPL), Programmer  
 Matthijs (“Matt”) van Domselaar (SIO), Data Analyst  
 Shannon Van Wyk (USGS), Field Technician

**SCIGN Volunteers**

Michael Duffy (Metropolitan Water District of Southern California)  
 Robert Packard (Chief Surveyor, City of Los Angeles, retired)  
 Robert Reader (Chief Surveyor, Los Angeles County, retired)  
 Art Varon (Chief Surveyor, Ventura County, retired)

Figure A1.  
 SCIGN  
 organizational  
 chart

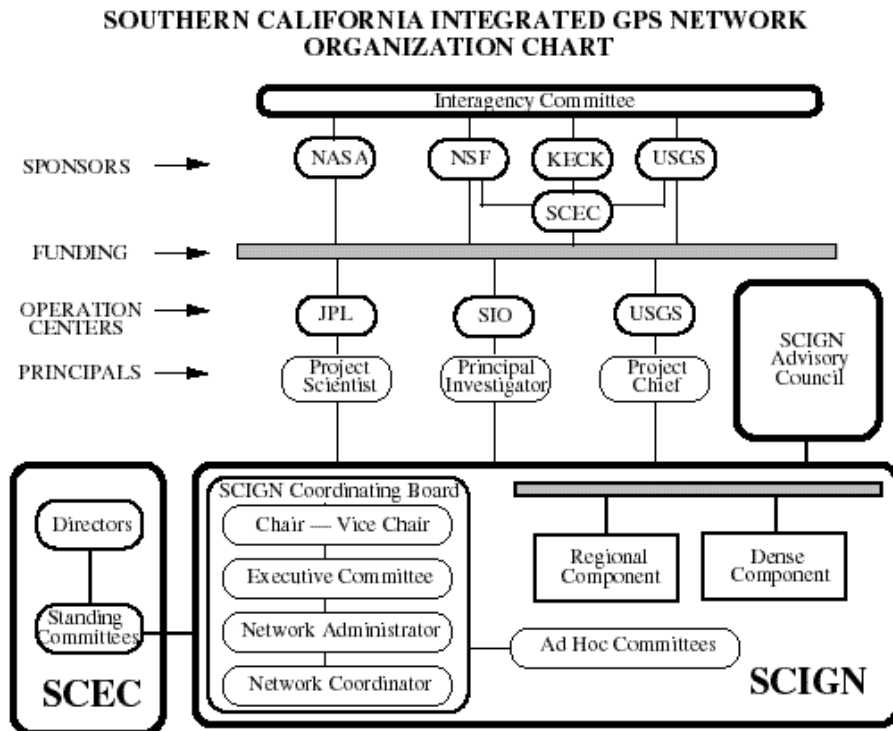

Figure A2.  
Outline of Responsibilities:  
Between the three operational centers of SCIGN, the responsibilities for all the main operational tasks are assigned as outlined in this chart (that was developed for the SCIGN Operational Plan).

Responsibility	Organization		
	JPL	SIO	USGS
<i>Installation Management</i>	Yes	Installation Training* Consult and Advise	Recon & Permitting*, Consult & Advise
<i>Maintenance and Downloading</i>	Technical Support Partial real-time download	Regional Backbone (~20% network)	Dense Component (~80% network)
<i>Analysis</i>	Yes	Yes	Consulting for real-time earthquake response*
<i>Archive</i>	Backup support	Primary	Transfer data to SIO
<i>Earthquake Response</i>	Analysis support	Analysis support	Yes
<i>R&amp;D</i>	Yes (Analysis)	Yes (Analysis/Archive)	Yes (Communications)

\* Extra responsibilities during the site construction phase

**External Committees:**

*SCIGN Interagency Committee*

This committee is composed of program managers from the Federal agencies that are providing funds to SCIGN. These include NASA, NSF, and USGS. The purpose of the committee is to promote communication and coordination at the multi-agency level so that SCIGN’s overall objectives can be met within the available resources, and reexamined periodically to evaluate new directions and initiatives. SCIGN plans to brief the committee on its activities and progress on a regular basis (approximately every six months).

Current Membership:

- Steve Bohlen (U.S. Geological Survey)
- John Filson (U.S. Geological Survey)
- Robin Reichlin (National Science Foundation)
- Dan Weill (National Science Foundation)
- Jim Whitcomb (National Science Foundation)
- John Labrecque (National Aeronautics and Space Administration)
- Earnie Paylor (National Aeronautics and Space Administration)

*SCIGN Advisory Council*

The SCIGN Board has established an Advisory Council to serve as an experienced advisory body to the Board. SCIGN has had three meetings with the Advisory Council in conjunction with the 1998 SCIGN Annual Meeting, 1998 SCEC Annual Meeting, and the 1999 SCIGN Annual Meeting.

Current Membership:

- Jeff Freymueller, Advisory Council Chair (University of Alaska)
- Michael Bevis (University of Hawaii)
- Herb Dragert (Pacific Geoscience Center)
- Diane Evans (NASA/Jet Propulsion Laboratory)

Egill Hauksson (California Institute of Technology)  
Bradford Hager (Massachusetts Institute of Technology)  
Teruyuki Kato (University of Tokyo)  
Charles Kennel (Scripps Institute of Oceanography, U. C. San Diego)  
John Orcutt (Scripps Institution of Oceanography, U. C. San Diego)  
Roland Burgmann (U. C. Berkeley)  
Jim Savage (U.S. Geological Survey)  
Paul Segall (Stanford University)



## REFERENCES

- Anderson, D.L., Earthquakes and the rotation of the earth, *Science*, **186**, 49-50, 1974.
- Atwater, T., and J. Stock, PAC-NAM plate tectonics of the Neogene Southwestern U.S.: an update, *Int. Geol. Rev.*, **40**, 375-402, 1998.
- Behr, J. A., K. Hudnut, and N. King, Monitoring structural deformation at Pacoima Dam, California, using continuous GPS, *Proceedings of the 11<sup>th</sup> International Technical Meeting of the Satellite Division of the Institute of Navigation* [ION GPS-98; Nashville, TN], pp. 59-68, 1998.
- Bennett, R. A. et al., Continuous GPS measurements of contemporary deformation across the northern Basin and Range province, *Geophys. Res. Lett.*, **25**, 563-566, 1998.
- Bock Y., S. Wdowinski, P. Fang, J. Zhang, S. Williams, H. Johnson, J. Behr, J. Genrich, J. Dean, M. van Domselaar, D. Agnew, F. Wyatt, K. Stark, B. Oral, K. Hudnut, R. King, T. Herring, S. Dinardo, W. Young, D. Jackson, and W. Gurtner, Southern California Permanent GPS Geodetic Array: Continuous measurements of crustal deformation between the 1992 Landers and 1994 Northridge earthquakes, *J. Geophys. Res.*, **102**, 18,013-18,033, 1997.
- Bott, M. H. P. and D. S. Dean, Stress diffusion from plate boundaries, *Nature*, **243**, 339-341, 1973.
- Celebi, M., W. Prescott, R. Stein, K. Hudnut, J. Behr, and S. Wilson, GPS monitoring of dynamic behavior of long-period structures, *Earthquake Spectra*, **15**, 55-66, 1999.
- Hudnut, K. W. and J. A. Behr, Continuous GPS monitoring of structural deformation at Pacoima Dam, California, *Seismol. Res. Lett.*, **69**, 299-308, 1998.
- King, G. C. P., R. S. Stein, and J. Lin, Static stress changes and the triggering of earthquakes, *Bull. Seismol. Soc. Amer.*, **84**, 935-953, 1994.
- Mogi, K., Sequential occurrences of recent great earthquakes, *J. Phys. Earth*, **16**, 30-36, 1968.
- Mogi, K., Migration of seismic activity, *Bull. Earthquake Research Institute*, **46**, Tokyo, 53-74, 1968.
- Mogi, K., Active periods in the world's seismic belts, *Tectonophys.*, **22**, 265-282, 1974.
- Mogi, K., Global variations of seismic activity, *Tectonophys.*, **57**, p. T43-T50, 1979.
- Nur, A. et al., The nature of the Landers-Mojave earthquake line, *Science*, **261**, 201-203, 1993.
- Peltzer, G., P. Rosen and K. Hudnut, Postseismic rebound in fault stopovers caused by pore fluid flow, *Science*, **273**, 1202-1204, 1996.
- Peltzer, G., K. W. Hudnut and K. Feigl, Analysis of coseismic surface displacement gradients using radar interferometry: New insights into the Landers earthquake, *J. Geophys. Res.*, **99**, 21,971-21,981, 1994.
- Peltzer, G., P. Rosen, F. Rogez and K. Hudnut, Poroelastic rebound along the Landers 1992 earthquake surface rupture, *J. Geophys. Res.*, **103**, 30,131-30,145, 1998.
- Pollitz, F. F., Gravitational viscoelastic postseismic relaxation on a layered spherical earth, *J. Geophys. Res.*, **102**, 17,921-17,941, 1997.
- Prescott, W., Y. Bock, K. Hudnut, M. Watkins, D. Agnew, A. Donnellan, L. Fenske, B. Hager, D. Jackson, J. Mori, D. D'Onofrio, B. Young, F. Webb, and F. Wyatt, Operations plan for the Southern California Integrated GPS Network, Fiscal Year 1996, USGS Open-File Report, 96-283, 86 pp., 1996.
- Press, F. and C. Allen, Patterns of seismic release in the southern California region, *J. Geophys. Res.*, **100**, 6421-6430, 1995.
- Sauber, J. et al., Geodetic slip rate for the eastern California shear zone and the recurrence time of Mojave desert earthquakes, *Nature*, **367**, 264-266, 1994.
- Savage, J. C., A theory of creep waves propagating along a transform fault, *J. Geophys. Res.*, **76**, 1954-1956, 1971.
- Savage, J. C. et al., An apparent shear zone trending north-northwest across the Mojave Desert into Owens Valley, eastern California, *Geophys. Res. Lett.*, **17**, 2113-2116, 1990.

- Savage, J.C. and J. L. Svarc, Postseismic deformation associated with the 1992 Mw=7.3 Landers California earthquake, southern California, *J. Geophys. Res.*, **102**, 7565-7577, 1997.
- Scientists from the USGS, SCEC, and CDMG, Preliminary report on the 16 October 1999 M 7.1 Hector Mine, California, earthquake, *Seismol. Res. Lett.*, **71**, 11-23, 2000.
- Segall, P. and J. L. Davis, GPS applications for geodynamics and earthquake studies, *Ann. Rev. Earth Planet. Sci.*, **25**, 301-336, 1997.
- Sieh, K. and others, Near-field investigations of the Landers earthquake sequence, April to July 1992, *Science*, **260**, 171-176, 1993.
- Silver, P. G., Y. Bock, D. C. Agnew, T. Henyey, A. T. Linde, T. V. McEvelly, J.-B. Minster, B. A. Romanowicz, I. S. Sachs, R. B. Smith, S. C. Solomon, S. A. Stein, "A plate boundary observatory," IRIS Newsletter, Vol. XVI, No. 2, pp. 3, 7-9, 1999.
- Stein, R., S. Barka, A. Aykut, and J. H. Dieterich, Progressive failure on the North Anatolian Fault since 1939 by earthquake stress triggering, *Geophys. J. Int.*, **128**, 594-604, 1997.
- Wallace, R. E., Patterns and timing of late Quaternary faulting in the Great Basin province and relation to some regional tectonic features, *J. Geophys. Res.*, **89**, 5763-5769, 1984.
- Wallace, R. E., Grouping and migration of surface faulting and variations in slip rates in faults in the Great Basin province, *BSSA*, **77**, 868-876, 1987.
- Wernicke, B. P. and J. K. Snow, Cenozoic tectonism in the central Basin & Range, motion of the Sierran-Great Valley block, *Int. Geol. Rev.*, **40**, 403-410, 1998.